

With fuseholder 5x20 mm / 6.3x32 mm, with or without voltage selector (step switch)

Standard- or Medical-Filter

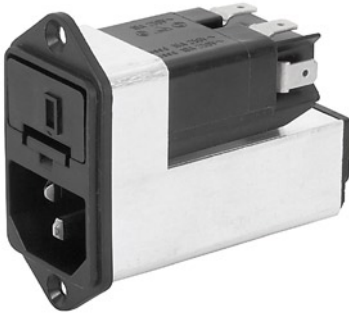

with voltage selector



without voltage selector



70° C



Description

- Panel Mount:
Screw-on from front side
- 4 Functions:
Inlet Protection class I, Fuseholder with interchangeable fuse drawer for Fuse-links 5 x 20 mm or 6.3 x 32 mm, with or without voltage selector (step switch), Line filter in standard and medical version
- Quick connect terminals 4.8 x 0.8 mm
- Alternative: version without line filter [KEC](#)

Approvals

- VDE License Number: 40004665 (FKO, FKP, FKQ, FKR)
- UL License Number: E72928 (FKO, FKP, FKQ, FKR)

Characteristics

- All single elements are already wired
- The fuse drawer "Fingergrip" can be removed by hand
For added safety "Extra-Safe" fuse drawers are available
Fuse drawer meets requirements of medical standard IEC/EN 60601-1
The fuse drawer can only be opened with the aid of a tool
The fuseholder is accessible from the equipment front
- Qualified for use in equipment according IEC/EN 60950

References

[General Product Information](#)

Weblinks

[Approvals](#), [RoHS](#), [CHINA-RoHS](#), [e-Store](#), [SCHURTER-Stock-Check](#), [Distributor-Stock-Check](#)

Technical Data

Ratings IEC	1 - 10A @ Ta 40 °C / 250VAC; 50Hz
Ratings UL/CSA	1 - 10A @ Ta 40 °C / 125VAC; 60Hz
Leakage Current	standard < 0.5 mA (250 V / 60Hz) medical < 5 µA (250 V / 60 Hz)
Dielectric Strength	> 1.7 kVDC between L-N > 2.7 kVDC between L/N-PE Test voltage (2 sec)
Allowable Operation Temp.	-25 °C to 85 °C
Climatic Category	25/085/21 acc. to IEC 60068-1
Degree of Protection	from front side IP 40 acc. to IEC 60529
Protection Class	Suitable for appliances with protection class I acc. to IEC 61140
Terminal	Quick connect terminals 4.8 x 0.8 mm
Panel Thickness s	Screw-on: max 8 mm Mounting screw torque max 0.5 Nm
Material: Housing	Thermoplastic, black, UL 94V-0

Appliance-Inlet /-Outlet	C14 acc. to IEC/EN 60320-1, UL 498, CSA C22.2 no. 42 (for cold condition) pin-temperature 70 °C, 10A, Protection class I
Fuseholder	1 or 2 pole, Shocksafe category PC2 acc. to IEC 60127-6, for fuse-links 5 x 20 or 6.3 x 32 mm
Rated Power Acceptance @ Ta 23 °C	5 x 20: 2.5W (1 pole)/ 2W (2-pole) per pole 6.3 x 32: 3.15W (1 pole)/ 2.5W (2-pole) per pole
Power Acceptance @ Ta > 23°C	Admissible power acceptance at higher ambient temperature see derating curves
Voltage selector	optional, step, 3 digits
Line Filter	Standard and Medical Version, IEC 60939, IEC 60601-1, UL 1283, UL 544, EN 133 200, CSA C22.2 no. 8 Technical details
MTBF	> 1'700'000h acc. to MIL-HB-217 F

Dimensions

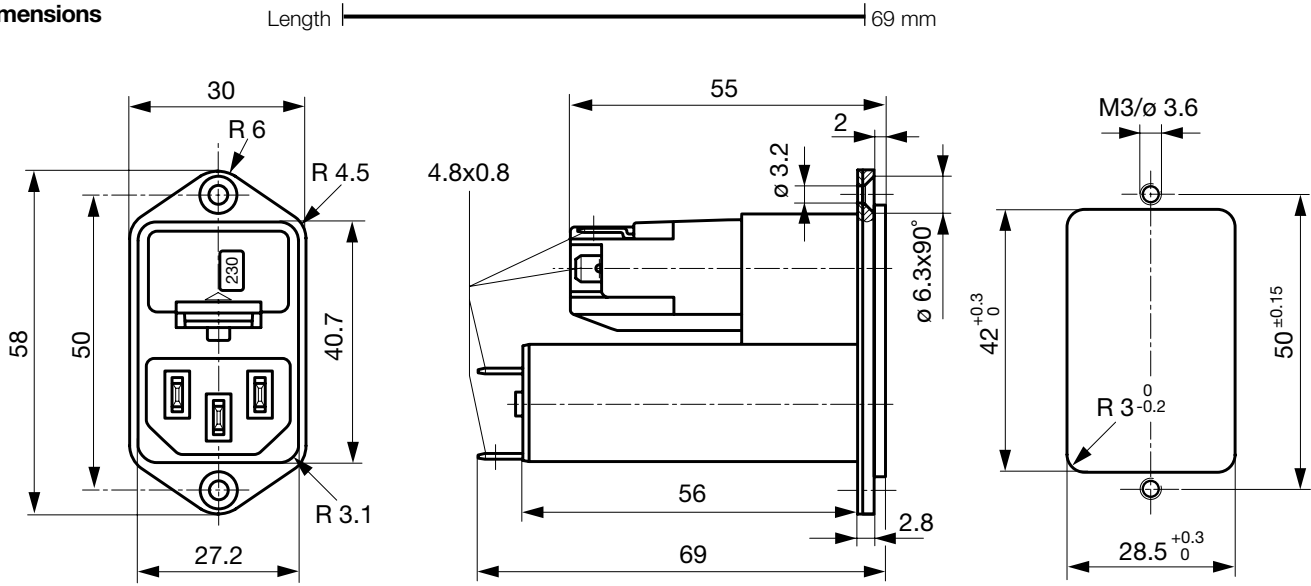

Technical Data of Filter-Components

Rated Current [A]	Filter-Type	Inductances L [mH]	Capacitance CX [nF]	Capacitance CY [nF]	R [MΩ]
1	Standard Version	2 x 10	68	2.2	-
2	Standard Version	2 x 4	68	2.2	-
4	Standard Version	2 x 1.5	68	2.2	-
6	Standard Version	2 x 0.8	68	2.2	-
10	Standard Version	2 x 0.3	68	2.2	-
1	Medical Version (M5)	2 x 10	68	-	1
2	Medical Version (M5)	2 x 4	68	-	1
4	Medical Version (M5)	2 x 1.5	68	-	1
6	Medical Version (M5)	2 x 0.8	68	-	1
10	Medical Version (M5)	2 x 0.3	68	-	1
10	Standard and Medical Version	2 x 0.3	68	2.2	1

Diagrams

Standard version with voltage selector

Medical version with voltage selector

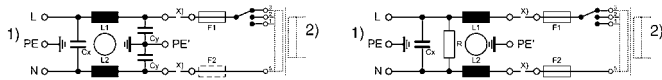

- 1) Line
- 2) Load
- x) External connection to be made by the customer

Derating Curves for Fuseholders

Fuses 5 x 20 mm (1-pole)

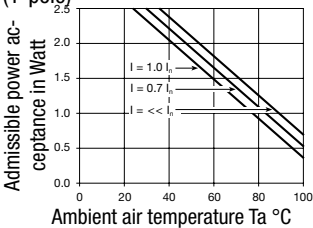

Fuses 5 x 20 mm (2-pole, per pole)

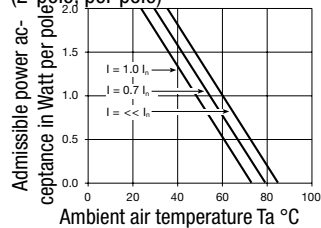

Fuses 6,3 x 32 mm (1-pole)

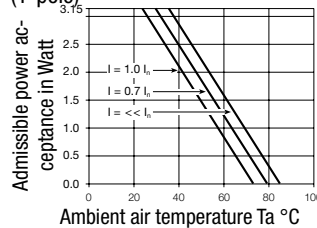

Fuses 6,3 x 32 mm (2-pole, per pole)

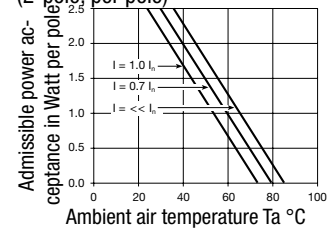

Attenuation Loss

--- differential mode — common mode

Standard version

1 A

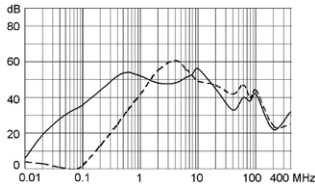

2 A

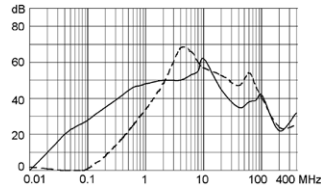

4 A

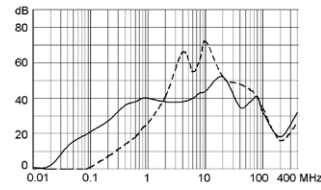

6 A

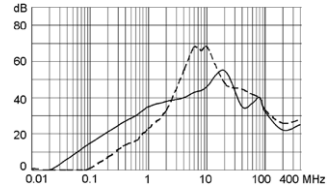

10 A

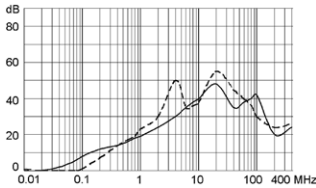

Medical version (M5)

1 A

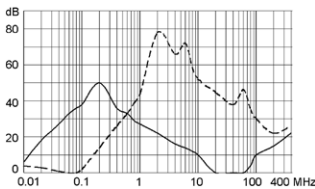

2 A

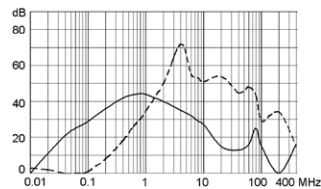

4 A

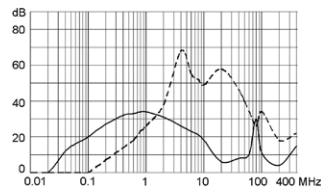

6 A

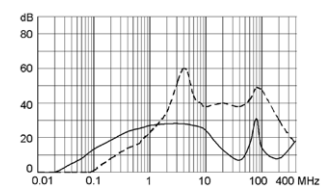

10 A

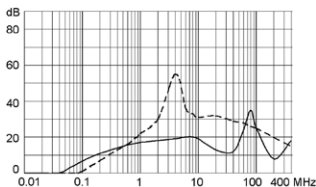

Variants

[Distributor-Stock-Check](#) | [SCHURTER-Stock-Check](#) | [e-Store](#)

Fuse drawer must be ordered separately (see accessories).

Rated Current [A]	Filter-Type	Fuseholder	Voltage selector	Order Number
1	Standard Version	1 pole	-	4303.5011
2	Standard Version	1 pole	-	4303.5012
4	Standard Version	1 pole	-	4303.5013
6	Standard Version	1 pole	-	4303.5014
10	Standard Version	1 pole	-	4303.5015
1	Standard Version	1 pole	3 digits	4303.5031
2	Standard Version	1 pole	3 digits	4303.5032
4	Standard Version	1 pole	3 digits	4303.5033
6	Standard Version	1 pole	3 digits	4303.5034
10	Standard Version	1 pole	3 digits	4303.5035
1	Standard Version	2-pole	-	4303.5001
2	Standard Version	2-pole	-	4303.5002
4	Standard Version	2-pole	-	4303.5003
6	Standard Version	2-pole	-	4303.5004
10	Standard Version	2-pole	-	4303.5005
1	Standard Version	2-pole	3 digits	4303.5021

Rated Current [A]	Filter-Type	Fuseholder	Voltage selector	Order Number
2	Standard Version	2-pole	3 digits	4303.5022
4	Standard Version	2-pole	3 digits	4303.5023
6	Standard Version	2-pole	3 digits	4303.5024
10	Standard Version	2-pole	3 digits	4303.5025
1	Medical Version (M5)	2-pole	3 digits	4303.5221
2	Medical Version (M5)	2-pole	3 digits	4303.5223
4	Medical Version (M5)	2-pole	3 digits	4303.5225
6	Medical Version (M5)	2-pole	3 digits	4303.5227
10	Medical Version (M5)	2-pole	3 digits	4303.5229

Packaging unit 10 Pcs

Required Accessory

Description

Fusedrawer 3
Drawers for fuse links 5x20mm resp. 6.3x32mm



Fingergrip, 5 x 20, 2-pole, Voltage selector	4303.2014.00
Fingergrip, 5 x 20, 2-pole, Voltage selector, 100, 120, 220, 240	4303.2014.01
Fingergrip, 5 x 20, 2-pole, Voltage selector, 110, 150, 220	4303.2014.02
Fingergrip, 5 x 20, 2-pole, Voltage selector, 110, 220	4303.2014.03
...	...

Accessory



Assorted Covers
Rear Cover

	0859.0072
--	-----------



Cord retaining kits
Cord retaining strain relieve

Flat head, A	4700.0001
--------------	-----------